

LF End Suction Pump

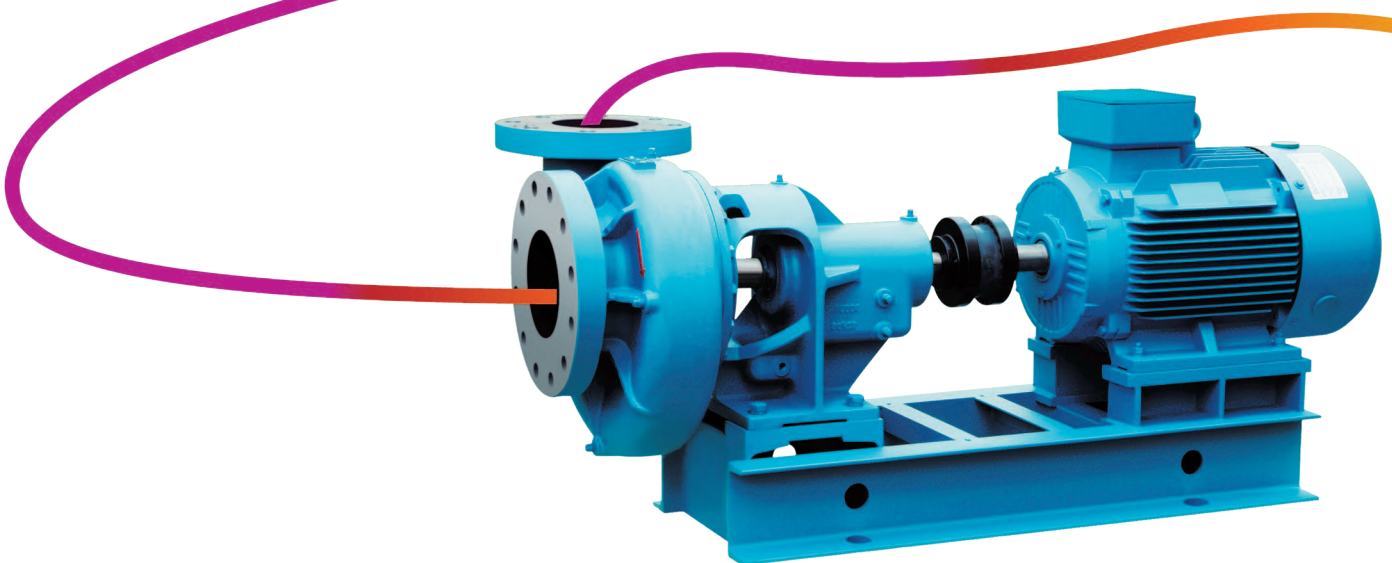

END SUCTION CENTRIFUGAL PUMPS

Culminating more than 90 years of commitment to advanced pump technology-PACO end suction pumps serve as industry standards in performance and reliability. These premium efficiency pumps reduce energy cost while providing higher flow per pump discharge size. They are available with double volute design providing longer life and reduced maintenance cost. Low operating costs are ensured even during off design operating conditions.

PACO's type LF is available in both horizontal and vertically mounted configurations.

Pump Model: LF

Technical Specifications

- › Capacities up to 2000 m³/h for 50 Hz
- › Heads up to 90 metres for 50 Hz
- › Maximum operating pressure of 12 or 16 bar (25 bar upon request)
- › Suction/ Discharge Diameter: 30 - 300 mm
- › Max Kilowatt: 200 kW
- › ANSI Flange connection

Working Conditions

- › Temperature standard for medium is 0 - 100°C (-20 - 135°C under special conditions & upon request)
- › Transfer clean water without particles

Applications

- › Chilled water
- › Condensate water
- › Commercial pools and water parks
- › Direct and indirect cooling water
- › Service water
- › Water distribution systems

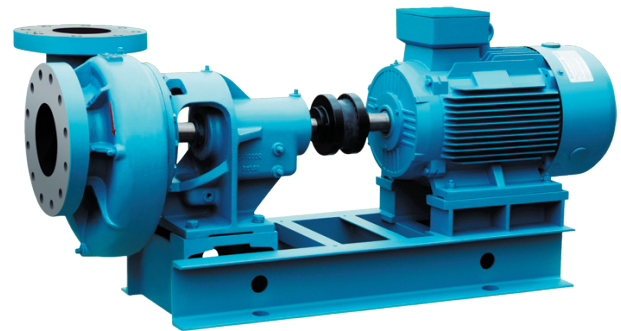

LF

Standard Material of Construction:

- Pump Casing: Cast Iron
- Impeller : Stainless steel 304
- Wear Ring : Bronze
- Shaft : Stainless steel 420
- Sealing : Mechanical Seal

PACO LF Family Chart - 2900rpm

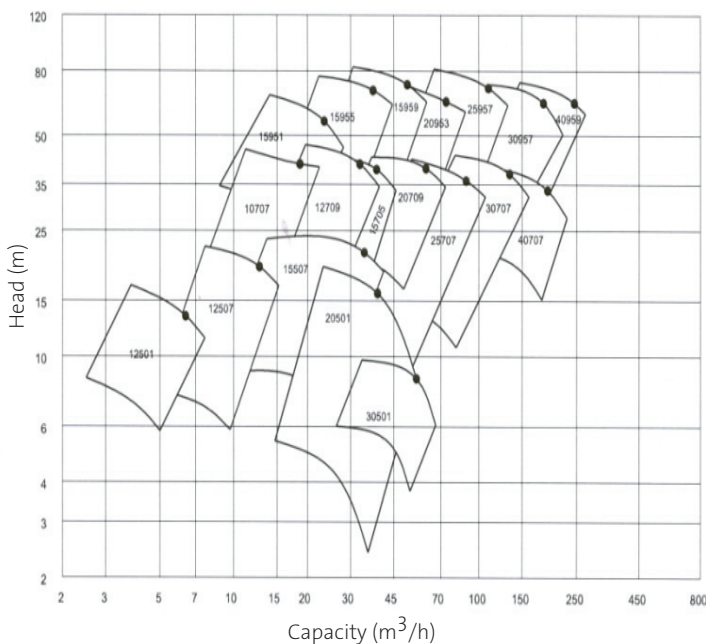

PACO LF Family Chart - 1450rpm

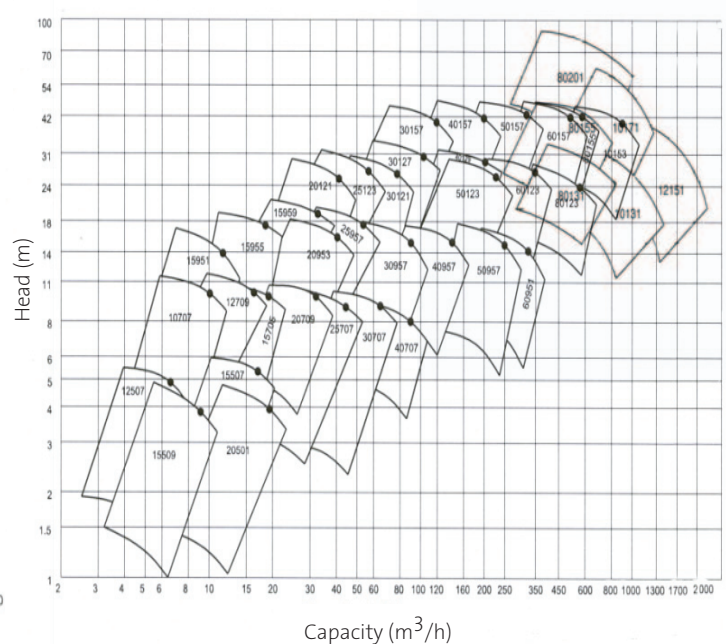

FEATURES & BENEFITS

1. BEARING HOUSING

2. BEARING

3. SHAFT

FEATURE: High strength steel shaft

BENEFIT: Shaft deflection minimized (.002" at worst case, at shutoff) to promote long bearing and seal life, reducing downtime and maintenance costs

4. DRAIN CONNECTION

BENEFITS: Allows for ease of maintenance and shorter downtime

5. VOLUTE

FEATURES: The compensated dual volute design virtually eliminates radial forces acting against the shaft, exceeding seal and bearing life. Double volute construction is available on selected pumps ranging above 4" discharge

BENEFITS: The double volute design improves efficiency by providing two individual volute passageway to guide the flow in the casing. This casing feature extends seal and bearing life, minimises vibration and provides quiet operation

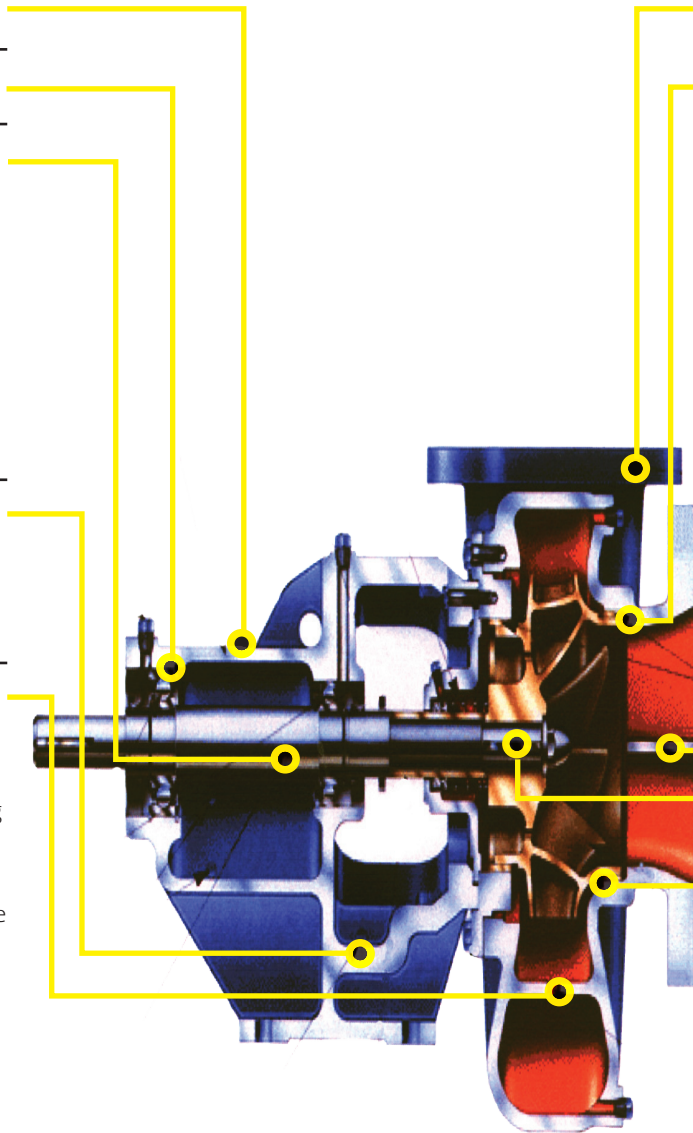

6. PUMP CASING

7. CASE WEAR RINGS

FEATURE: Replaceable lead free bronze case wear rings
BENEFIT: Promote extended casing life, reducing maintenance costs and downtime

8. SUCTION SPLITTER

FEATURE: Integrally cast suction splitter
BENEFITS: Requires minimal suction pipe, while reducing turbulence, providing for lower installation and operating costs

9. MECHANICAL SHAFT SEAL

10. IMPELLER

FEATURE: Francis Vane Impeller design
BENEFITS: Produces broad band high efficiency and low NPSH, provides quiet performance, minimum vibration and reduced operating costs

PACO's experience, plus their commitment to quality and an aggressive research and development programme, has produced the finest premium efficient pumps in the industry.

Using computer aided design technology, PACO has developed pumps producing operating high efficiencies, thereby reducing operating costs and saving money. The innovative impeller and pump design produces a higher operating condition efficiency and provides a wider band of best efficiency.

As a result, low operating costs are ensured even during off design operating conditions.

HVAC PIPING ACCESSORIES



PSD (Suction diffuser)

Features:

- > Eliminates need for 90° elbow, stainer, flow stabilizer and reducer
- > Simplifies pump installation
- > Minimizes costs
- > Promotes smooth, even flow profile
- > Stainless-steel strainer
- > Size 2" to 16"
- > 125# ANSI flanges
- > Standard working pressure: 175 psi (non standard psi rating available upon request)



CBS (Combination valve)

Features:

- > Functions as check valve, shutoff valve and balance valve
- > Simplifies pump installation
- > Minimizes costs
- > Promotes smooth, even flow profile
- > Spring-loaded bronze disc minimizes chatter
- > Vertical or horizontal orientation
- > Size 2" to 12"
- > 125# ANSI flanges
- > Standard working pressure: 175psi (non standard psi rating available upon request)

AFTER SALES, PARTS AND SERVICE

Grundfos Pumps Sdn Bhd is committed to After Sales Service. Highly trained technicians can assist customers with initial start-up, troubleshooting, service and repair.

Our technicians can evaluate your system's energy usage with the pumping systems assessment tools and provide recommendations for the engineers and facility operators.

Genuine PACO parts are pre-engineered and pre-packaged to simplify selection, ordering, and stocking. Virtually all required parts for PACO products are available as kits.

*Optional Offer: Laser Alignment at site by Grundfos Pumps Sdn Bhd

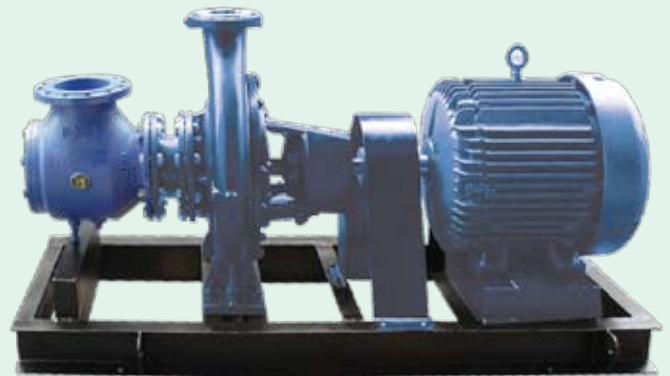

GRUNDFOS PUMPS SDN BHD (202527-A)

7, Jalan Peguam U1/25
Glenmarie Industrial Park
40150 Shah Alam, Selangor,
Malaysia.

Tel : +603-5569 2922
Fax : +603-5569 2866

E-mail: gfosmy1@grundfos.com

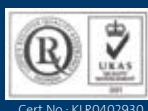

Cert No.: KLR0402930

Branch Office
Northern & East Coast
10, Ground Floor,
Jalan Todak 4, Bandar Sunway,
13700 Seberang Jaya,
Penang
Tel : +604-818 3779
Fax : +604-818 3848

East Malaysia
Lot 8, Lorong Industri Warisan 1,
Taman Industri Warisan Indah,
Mile 7, Old Tuaran Road
88450 Inanam, Kota Kinabalu,
Sabah
Tel : +6088-380 663/-383 663
Fax : +6088-383 621